

281R Series LED Lights

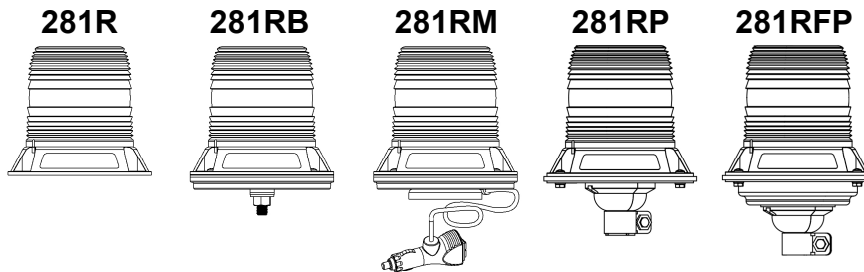

These lights utilize high-intensity LEDs. Do not stare directly into the light while it is on, as momentary blindness and/or permanent eye damage may occur.

LED FIVE YEAR LIMITED WARRANTY

The manufacturer warrants this LED light against factory defects in material and workmanship for five years after the date of purchase. The owner will be responsible for returning to the Service Center any defective item(s) with the transportation costs prepaid. The manufacturer will, without charge, repair or replace *at its option*, products, or part(s), which its inspection determines to be defective. Repaired or replacement item(s) will be returned to the purchaser with transportation costs prepaid from the service point. A copy of the purchaser's receipt must be returned with the defective item(s) in order to qualify for the warranty coverage. Exclusions from this warranty include, but are not limited to, domes, and/or the finish. This warranty shall not apply to any light, which has been altered, such that in the manufacturer's judgment, the performance or reliability has been affected, or if any damage has resulted from abnormal use or service.

There are no warranties expressed or implied (including any warranty of merchantability or fitness), which extend this warranty period. **The loss of use of the product, loss of time, inconvenience, commercial loss or consequential damages, including costs of any labor, are not covered.** The manufacturer reserves the right to change the design of the product without assuming any obligation to modify any product previously manufactured.

This warranty gives you specific legal rights. You might also have additional rights that may vary from state to state. Some states do not allow limitations on how long an implied warranty lasts. Some states do not allow the exclusion or limitation of incidental or consequential damages. Therefore, the above limitation(s) or exclusion(s) may not apply to you.

Permanent Mounting (281R Series)

Use appropriate hardware (user supplied) to mount the light through the three holes located in the flange, routing the wires through a pre-drilled center hole in your mounting surface.

Ø 5.1"-6.0"
Ø 130MM-150MM
SPACED EVENLY 120°

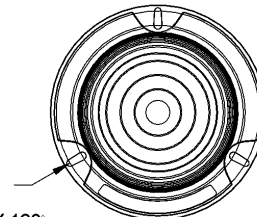

PLIT581 REV. C 3/4/19

Single Bolt Mounting (281RB Series)

The 281RB series is designed to be mounted through a single 1/2" or 13mm hole and secured with the enclosed M12 nut.

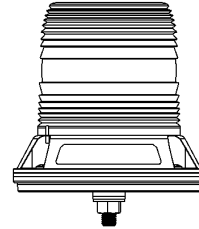

DIN Mounting (281RP and 281RFP Series)

These models are designed with a standard flexible European DIN (pipe/pole) mount. You must have the mating mount installed on your vehicle to utilize this light.

To install, loosen the wing nut, slide the light onto the mount, and tighten the wing nut.

Please note that the DIN mount versions are 12-24VDC and do not have the **Pattern Programming** or **Synchronization** features mentioned on the following pages.

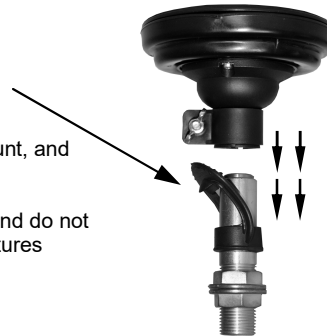

Magnet Mounting (281RM Series)

*If you are mounting the light on the roof of your vehicle, take extreme care to ensure that the magnet is firmly seated on your roof, and that the pull of the magnet is sufficient to secure the light in place. As the composition of the metal in the roofs of different vehicles may vary, as well as the contour, texture and/or condition, Star cannot guarantee the ability of the light to remain in place upon a moving vehicle. **It is the sole responsibility of the owner to ensure the warning light is secure.***

WARNING!!! Care should be taken when positioning any warning light on the roof, dash, or instrument panel of the vehicle, so that the light and/or cord does not interfere with the proper operation of any airbags! Failure to heed this warning may result in serious or fatal injury.

- **CAUTION:** Please be sure to check that your cigarette plug outlet is properly fused. **Testing the light before this fuse is properly installed will void the warranty on the light.**
- This light has been factory tested and approved. If the light fails to work when the plug is inserted into the cigarette plug socket, twist the plug a few times to remove any ash or other deposits which might be preventing a good contact from being made. If the problem persists, check for a fuse inside of the plug itself. If present, remove the fuse from the circuit, check to see if it has blown, and clean the lighter socket and contact surfaces. Reconnect the fuse and test the light again.

Please Note: The magnet mounted versions with cig plugs are 12-24VDC and do not have the **Pattern Programming** or **Synchronization** features mentioned on the following pages.

Wiring Instructions (281R Series)

CAUTION: All of our DC powered warning lights are polarity sensitive. All wires connected to the positive terminal of the battery should be fused at the battery for their rated load. **Testing the light before this fuse is properly installed will void the warranty on the light.**

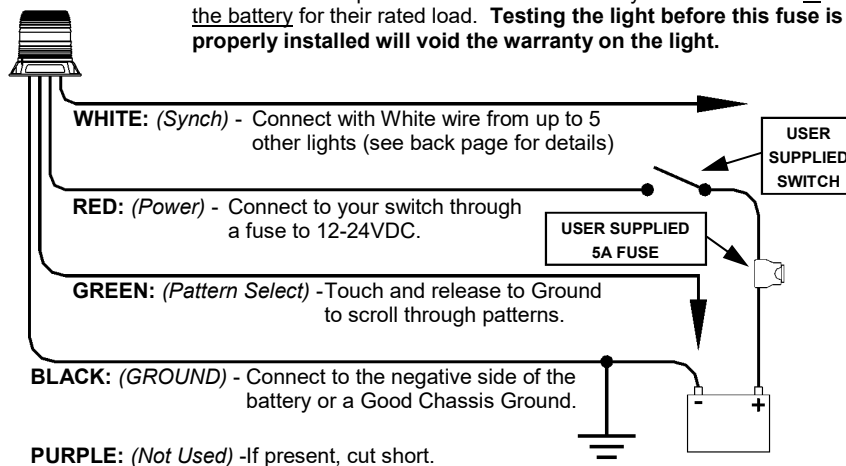

Pattern Programming

(Excludes DIN and Mag Mount Versions)

Change the flash pattern by touching and releasing the Green wire to BAT - (Neg)/Ground.

Phase 1 Flash Pattern	Phase 2 Flash Pattern	Pattern Type	Pattern Description	Shortcuts
1	15	K	Flicker †	
2	16	L	SAE Doubleflash †	Pattern 2 (Phase 1): 6 sec or 2 flash
3	17	M	Tripleflash †	
4	18	A5	Rotation 1 (Phase 1=CW Phase 2=CCW) †	Pattern 16 (Phase 2): 12 sec or 4 flashes
5	19	A6	Rotation 2 (Phase 1=CW Phase 2=CCW)	
6	20	F	Quadflash †	
7	21	G	Quadflash w/Post-Pop †	
8	22	H	Singleflash †	
9	13	I	Doubleflash †	Pattern 13 (Phase 1): 3 sec or 1 flash
10	24	J	Variable AKA Delta-Omega	
11	25	C	Post pop 1.4CPS †	Pattern 27 (Phase 2): 9 sec or 3 flashes
12	26	E	Random 0.4CPS	
13	27	A4	ECE Doubleflash †	
14	28	A3	ECE Quadflash †	
NA			Steady	18 Sec/5 Blinks

† - Approved patterns for SAE J845

Pattern Shortcuts: Hold Green wire to ground for indicated time.

Steady Burn: Not in pattern cycle. Only accessible through shortcut. Hold Green wire to ground for 18 seconds (light will flash 5 times)

Synchronization of Multiple Lights

(Hardwire versions only)

SYNCHRONIZATION

You can synchronize up to six lights with  compatibility.

DO NOT CONNECT WHITE WIRES UNTIL PROGRAMMING HAS BEEN COMPLETED FOR ALL LIGHTS!!

1. Power up the first unit and select a Phase 1 pattern.
2. Program the second light with the same **Pattern Type**.
Lights with the SAME phase flash together (simultaneous).
Lights with DIFFERENT phases flash opposite one another (alternate).
3. After programming all lights, tie off the green wires and connect the white wires together.
4. Test lights by applying power to all of them at the same time.

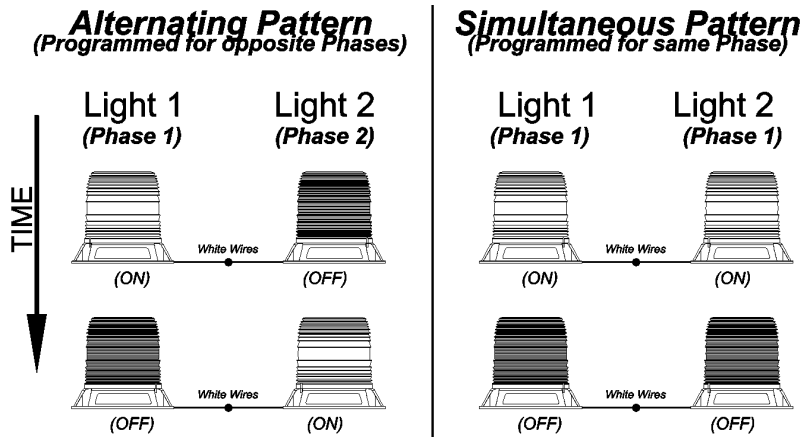

If you have any questions concerning this or any other product, please contact our **Customer Service Department** at (585) 226-9787.

If a product must be returned for any reason, please contact our Customer Service Department to obtain a Returned Materials Authorization number (RMA #) before you ship the product back. Please write the RMA # clearly on the package near the mailing label.

Star Headlight & Lantern Co., Inc.
 455 Rochester Street Avon, NY 14414 Phone: 585-226-9787 FAX: 888-478-2797



www.starheadlight.com